

Mod. **ARVTR70**

BN20SC050235

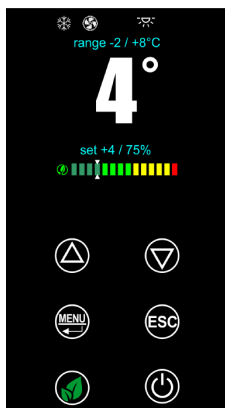

MAIN FEATURES

- Monobody construction with internal and external finish in Stainless Steel (Scotch-Brite satin)
- External back panel in prepainted steel
- External bottom in stainless steel, internal bottom molded to containment
- Inner room with rounded corners for easy cleaning and hygiene
- 85/93 mm insulation thickness
- Copper-aluminum evaporator with cataphoresis anti-corrosion treatment
- Painted iron condensing coil with high thermal output
- Front opening panel to facilitate periodic maintenance (condenser cleaning)
- Magnetic gasket on four sides and counter-magnet on the gasket ledge
- Lower hinge fixed frontally for installation on plinth
- Ergonomic full-height door handle
- Stainless steel feet Ø 2" height-adjustable H 150÷180mm with anti-scratch cap

INTERNAL SETUP:

- Internal compartment with 24-position molded sides, 3 Rilsan GN2/1 grids supplied
- LED light

COOLING SYSTEM:

- Electrical connection with Schuko 230V-1Ph-50Hz plug
- System mounted on a single block structure with steps, which enables optimal use of internal space
- Ecological refrigerant R290 for chiller and freezer condensing units
- Indirect ventilation thanks to the full height ducting system
- Automatic condensation water evaporation device without electric power supply
- Connectivity (optional)

CONTROLS AND SAFETY DEVICES:

- Multilingual touch screen control board with set function, recipe book, humidity set, HACCP, ECO function
- Maestro[®] self-learning software
- Control equipped with Coldroom probe and evaporator probe
- Compressor with automatic reset thermal protector against overheating
- Evaporator fan stops automatically when door is opened
- Alarm signaling: HACCP, AH / AL (high / low temperature), Open Door
- The alarms and the operating data can be viewed a PC using dedicated software

VERSIONS / ACCESSORIES (OPTIONALS):

- Water-cooled unit

Mod. **ARVTR70**

BN20SC050235

Revolving castors

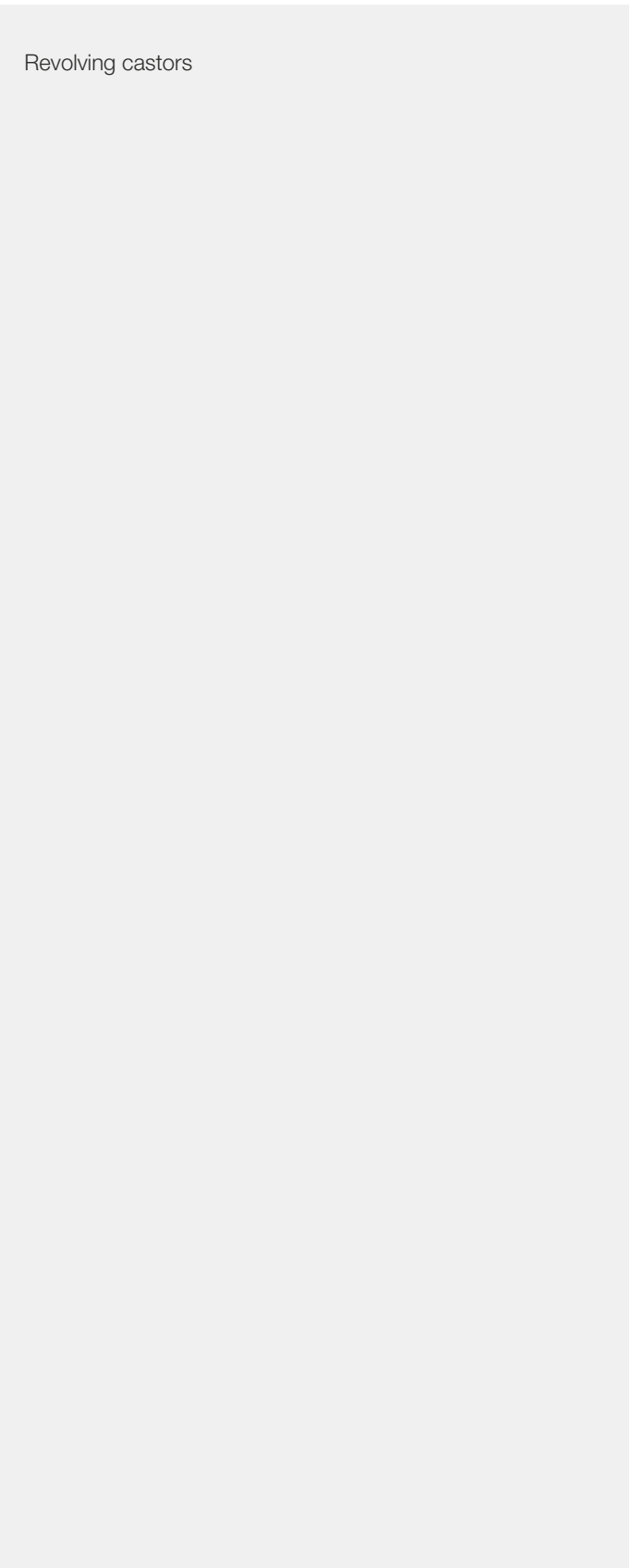

Mod. **ARVTR70**

BN20SC050235

MODELLO:		ARVTR70
NET WIDTH	mm	700
NET DEPTH	mm	830
90° OPENING DOOR DEPTH	mm	1450
NET HEIGHT	mm	2080
NET WEIGHT	Kg	117
PACKED WIDTH	mm	760
PACKED DEPTH	mm	860
PACKED HEIGHT	mm	2220
PACKED WEIGHT	Kg	130
PACKED VOLUME	m ³	1.45
NET HEIGHT DOOR	mm	1480
DOOR OPENING WIDTH	mm	534
INNER DEPTH	mm	710
INSULATION THICKNESS	mm	85
FLOOR HEIGHT	mm	225
N° OF COMPARTMENTS	n°	1
N° OF DOORS	n°	1
INTERNAL SETUP		3 GN1/1
POWER SUPPLY		230/1/50
CAPACITY	Lt	490
NUMBER OF LOAD POSITIONS	n°	24
PITCH	mm	55
REFRIGERANT	gas	R290
CONSUMO (UNI EN 16825)	kWh/24h	1.92
NOMINAL CURRENT	A	3.68
DEFROST TYPE		elettric
ABSORBED ELECTRICAL POWER	W	275
COOLING POWER	W	425
NOIS LEVEL	dB(A)	45
QUANTITY CHARGE GAS	g	51
CLIMATE CLASS		5
ENERGY CLASS		E
TEMPERATURE	°C	-2 +8
UKCA		X





(*) NT - Evap. Temperature -10°C / Cond. Temperature +45°C

(**) BT-Cecomaf Evap. temperature-25°C/Cond. temperature +45°C

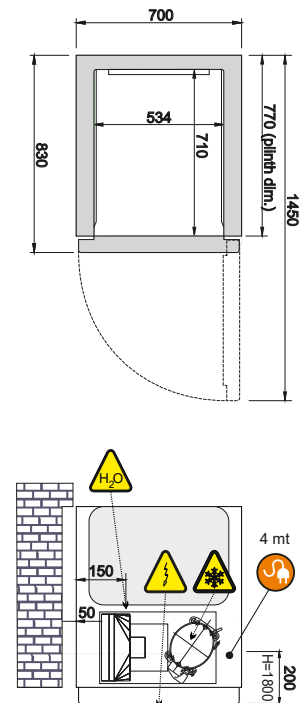
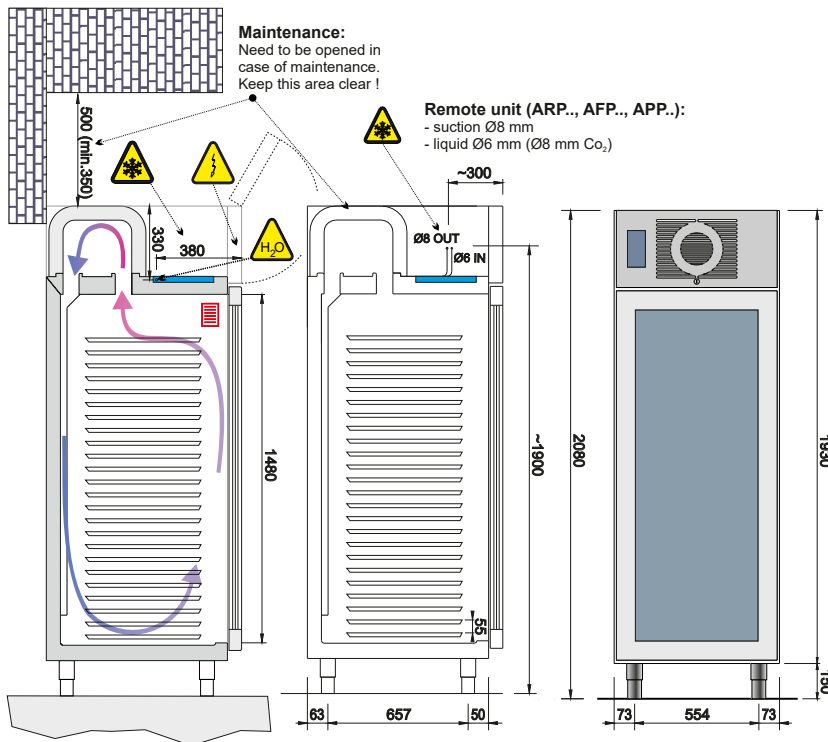
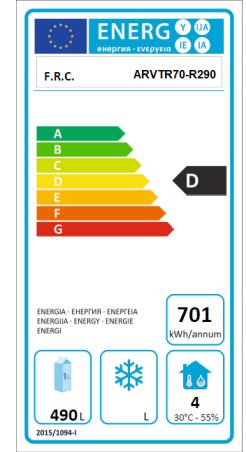
Mod. **ARVTR70**

BN20SC050235



 4 mt	Power cable position & length / Position und Länge des Speisekabels / Posizione e lunghezza cavo alim.	 H ₂ O	Drainage pipe / Ablaufrohr / Tubo scarico
	Refrigerant tubes / Kälteleitungen / Tubi refrigerante		Electrical components position / Position der elektrischen Komponente